

# Brake & Fuel Lines

---

# Fittings & Parts

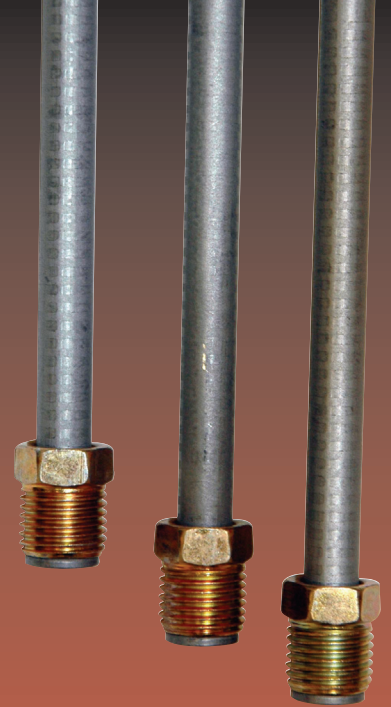

Domestic & Import Brake - Fuel & Transmission Line  
- Brake Line Fittings & Adapters - Assortments  
- Displays



*JohnDow*  
***Dynamic***<sup>TM</sup>  
Automotive Fasteners & Supplies

Toll-Free  
**888-571-1141**

[www.dynamicautosupplies.com](http://www.dynamicautosupplies.com)

## Table of Contents

### Brakes

Adapter Brake Lines.....	6
Adapter Fitting .....	9
Bleeder Screws .....	7
Brake Fitting Kits.....	10-12
Brake Fittings - Retail.....	11
Brake Line Clamps .....	7
Brake Line Displays .....	4
Brake Line Flare Tool .....	5
Brake Line .....	3-4
Coil Brake Line .....	5
Compression Fittings.....	7
Tube Nuts.....	8
Unions .....	7

### Fuel Systems

Fuel Line Fittings & Adapters .....	13
Fuel Line Fittings & Assortment ..	14
Fuel Line Repair Tool .....	15

## Flare Types

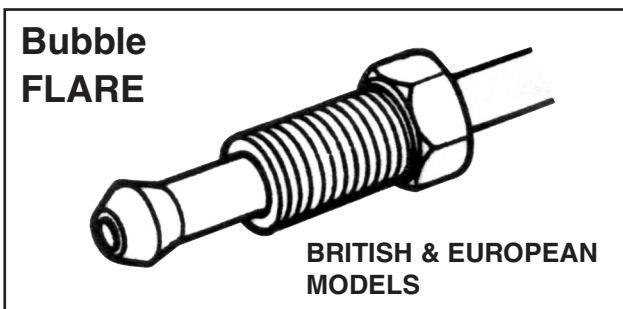
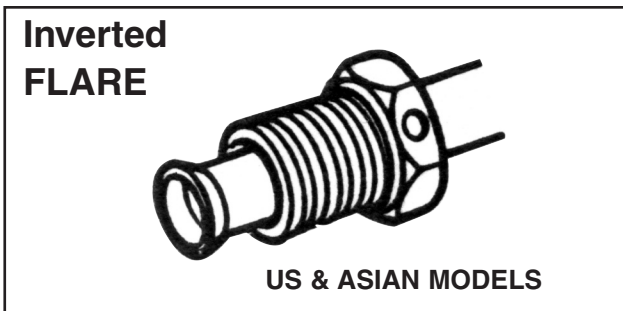

## Brake Line Coating

Dynamic offers three superior quality types of brake line - each offering excellent performance and corrosion resistance.

**GALFAN®** - is a durable coating that helps resist abrasion and is a step above the many zinc coated brake lines on the market today.

It will not chip, soften or blister when exposed to corrosive fluids. Galfan® utilizes a hot dip coat of zinc aluminum alloy plus a thermoset aluminum rich epoxy top coat. It exceeds 2,000 hours of salt spray testing. Galfan® meets stringent auto industry requirements.

- Double-walled construction.
- Zinc coated.
- Aluminum epoxy top coat.

**PVF** - Polyvinylfluoride is a durable, highly abrasion resistant coating. It is another option for corrosion protection on double-walled brake lines.

This coating consists of a PVF topcoat that is painted and cured over an electroplated zinc substrate. PVF exceeds 2,000 hours of salt spray testing.

- Double-walled construction.
- Zinc coated.
- Polyvinylfluoride topcoat.
- Olive green color.

**Copper-Nickel** - is an alloy of 90% copper and 10% nickel which has a very high corrosion resistance. It outperforms standard double-walled tubing.

Copper-Nickel is easy to bend and flare for trouble-free installation.

It provides superior reliability and durability for long-life functioning of the brake system.

# Domestic Steel Brake Lines

## Galfan® Coated

## PVF Coated

### 3/16" Domestic Steel Line - Standard Inverted Flare

Fittings: 105B & 105BL

Part No.	Description	Lines Per Tube	Part No.	Description	Lines Per Tube
BL-308	3/16" x 8"	10	PL-308	3/16" x 8"	10
BL-312	3/16" x 12"	10	PL-312	3/16" x 12"	10
BL-320	3/16" x 20"	10	PL-320	3/16" x 20"	10
BL-330	3/16" x 30"	10	PL-330	3/16" x 30"	10
BL-340	3/16" x 40"	10	PL-340	3/16" x 40"	10
BL-351	3/16" x 51"	10	PL-351	3/16" x 51"	10
BL-360	3/16" x 60"	10	PL-360	3/16" x 60"	10
BL-372	3/16" x 72"	10	PL-372	3/16" x 72"	10

### 1/4" Domestic Steel Line - Standard Inverted Flare

Fittings: 105C & 105CL

Part No.	Description	Lines Per Tube	Part No.	Description	Lines Per Tube
BL-408	1/4" x 8"	10	PL-408	1/4" x 8"	10
BL-412	1/4" x 12"	10	PL-412	1/4" x 12"	10
BL-420	1/4" x 20"	10	PL-420	1/4" x 20"	10
BL-430	1/4" x 30"	10	PL-430	1/4" x 30"	10
BL-440	1/4" x 40"	10	PL-440	1/4" x 40"	10
BL-451	1/4" x 51"	10	PL-451	1/4" x 51"	10
BL-460	1/4" x 60"	10	PL-460	1/4" x 60"	10
BL-472	1/4" x 72"	10	PL-472	1/4" x 72"	10

### 5/16" Domestic Steel Line - Standard Inverted Flare

Fittings: 105D

Part No.	Description	Lines Per Tube	Part No.	Description	Lines Per Tube
BL-508	5/16" x 8"	5	PL-508	5/16" x 8"	5
BL-512	5/16" x 12"	5	PL-512	5/16" x 12"	5
BL-520	5/16" x 20"	5	PL-520	5/16" x 20"	5
BL-530	5/16" x 30"	5	PL-530	5/16" x 30"	5
BL-540	5/16" x 40"	5	PL-540	5/16" x 40"	5
BL-551	5/16" x 51"	5	PL-551	5/16" x 51"	5
BL-560	5/16" x 60"	5	PL-560	5/16" x 60"	5
BL-572	5/16" x 72"	5	PL-572	5/16" x 72"	5

### 3/8" Domestic Steel Line - Standard Inverted Flare

Fittings: 105E

Part No.	Description	Lines Per Tube	Part No.	Description	Lines Per Tube
BL-608	3/8" x 8"	4	PL-608	3/8" x 8"	4
BL-612	3/8" x 12"	4	PL-612	3/8" x 12"	4
BL-620	3/8" x 20"	4	PL-620	3/8" x 20"	4
BL-630	3/8" x 30"	4	PL-630	3/8" x 30"	4
BL-640	3/8" x 40"	4	PL-640	3/8" x 40"	4
BL-651	3/8" x 51"	4	PL-651	3/8" x 51"	4
BL-660	3/8" x 60"	4	PL-660	3/8" x 60"	4
BL-672	3/8" x 72"	4	PL-672	3/8" x 72"	4

## Galfan® Coated

## PVF Coated

### 3/16" British Steel Line - Bubble Flare - 3/8-24

Fittings: 7802

Part No.	Description	Lines Per Tube
ML-308	3/16" x 8"	5
ML-312	3/16" x 12"	5
ML-320	3/16" x 20"	5
ML-330	3/16" x 30"	5
ML-340	3/16" x 40"	5
ML-351	3/16" x 51"	5
ML-360	3/16" x 60"	5

Part No.	Description	Lines Per Tube
PML-308	3/16" x 8"	5
PML-312	3/16" x 12"	5
PML-320	3/16" x 20"	5
PML-330	3/16" x 30"	5
PML-340	3/16" x 40"	5
PML-351	3/16" x 51"	5
PML-360	3/16" x 60"	5

### 3/16" European Steel Line - Bubble Flare - M10 x 1.0

Fittings: 7801

Part No.	Description	Lines Per Tube
ML-3308	3/16" x 8"	5
ML-3312	3/16" x 12"	5
ML-3320	3/16" x 20"	5
ML-3330	3/16" x 30"	5
ML-3340	3/16" x 40"	5
ML-3351	3/16" x 51"	5
ML-3360	3/16" x 60"	5

Part No.	Description	Lines Per Tube
PML-3308	3/16" x 8"	5
PML-3312	3/16" x 12"	5
PML-3320	3/16" x 20"	5
PML-3330	3/16" x 30"	5
PML-3340	3/16" x 40"	5
PML-3351	3/16" x 51"	5
PML-3360	3/16" x 60"	5

### 3/16" Japanese Steel Line - Standard Flare - M10 x 1.0

Fittings: 7800

Part No.	Description	Lines Per Tube
ML-4308	3/16" x 8"	5
ML-4312	3/16" x 12"	5
ML-4320	3/16" x 20"	5
ML-4330	3/16" x 30"	5
ML-4340	3/16" x 40"	5
ML-4351	3/16" x 51"	5
ML-4360	3/16" x 60"	5

Part No.	Description	Lines Per Tube
PML-4308	3/16" x 8"	5
PML-4312	3/16" x 12"	5
PML-4320	3/16" x 20"	5
PML-4330	3/16" x 30"	5
PML-4340	3/16" x 40"	5
PML-4351	3/16" x 51"	5
PML-4360	3/16" x 60"	5

## Brake Line Racks

### Floor Display No. FBD-24

- Heavy-duty wire construction.
- Black powder-coat finish.
- Holds 24 tubes of brake line - 8" to 72" lengths.
- Includes line identification placard.



### Wall Rack No. WBD-7

- Heavy-duty wire construction.
- Black powder-coat finish.
- Holds 7 sizes - up to 10 brake lines per slot.
- Mounting tabs make easy wall installation.
- Includes line identification placard.

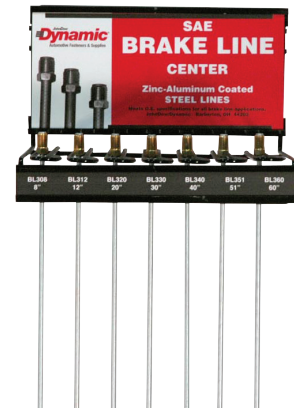





## Copper-Nickel Brake Line

*Copper-Nickel is an alloy of 90% copper and 10% nickel which has a very high corrosion resistance.*

- Outperforms standard double-walled tubing
- Approved for automotive braking systems
- Fast and easy installation
- Most bends made by hand
- Increase productivity and increases profits
- Conveniently coiled for easier storage and handling
- Sizes for both brake line and fuel line replacement

Part No.	Description	Coil Length	Application
CN-316	3/16"	25'	Brake
CN-316-50	3/16"	50'	Brake
CN-316-100	3/16"	100'	Brake
CN-38	3/8"	25'	Brake
CN-414	1/4"	25"	Brake
CN-414-50	1/4"	50'	Brake
CN-414-100	1/4"	100'	Brake
CN-516	5/16"	25'	Fuel

## Steel Brake Line

### Galfan® Coated

Part No.	Description	Coil Length	Application
BL-316	3/16"	25'	Brake
BL-414	1/4"	25'	Brake
BL-516	5/16"	25'	Fuel/Trans
BL-638	3/8"	25'	Fuel/Trans

### PVF Coated

Part No.	Description	Coil Length	Application
PV-316	3/16"	25'	Brake
PV-414	1/4"	25'	Brake
PV-516	5/16"	25'	Fuel/Trans

## BFT-1000 Brake Line Flaring Tool

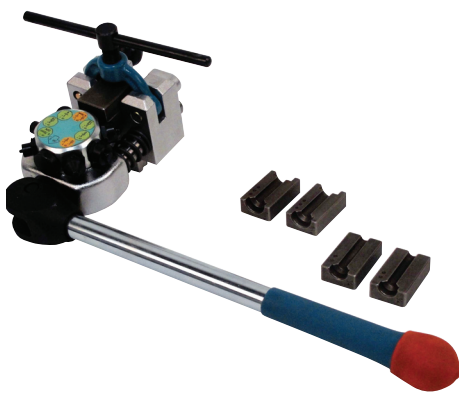

*This professional tool makes flaring brake lines simple, fast and precise*

- Makes 45° single and double brake flares in seconds
- Works with steel and copper tubing - 3/16", 1/4", 5/16" and 3/8" diameter
- Use it for brake lines, transmission cooler lines and fuel lines
- Turret-style design keeps all of the forming dies ready to use
- T-handle screw clamp securely holds tube in place during forming
- Vise mounting

## 3/16" Adapter Brake Lines - 8"

Part No.	Description	Qty Per Tube	Fitting (A) Size/Part No	Fitting (B) Size/Part No	Optional Adapter
BLA-101	1/4" Dom to 3/16" Dom	5	3/8-24 Inv (105B)	7/16-24 Inv (7955)	BR-7818
BLA-102	5/16" Dom to 3/16" Dom	5	3/8-24 Inv (105B)	1/2-20 Inv (-)	BR-7909
BLA-103	5/16" Dom to 3/16" Dom	5	3/8-24 Inv (105B)	1/2-20 Inv (7956)	BR-7909
BLA-105	9-16" Dom to 3/16" Dom	5	3/8-24 Inv (105B)	9/16-18 (7948)	BR-7911
BLA-107	European to 3/16" Dom	5	3/8-24 Inv (105B)	M10 x 1.0 Bub (7801)	BR-1442
BLA-108	Asian to Domestic	5	3/8-24 Inv (105B)	M10 x 1.0 Inv (7800)	BR-1443
BLA-109	Metric Bub to Dom	5	3/8-24 Inv (105B)	M11 x 1.5 Bub (7945)	BR-1445
BLA-110	Metric Bub to Dom	5	3/8-24 Inv (105B)	M12 x 1/0 Bub (7946)	BR-1446
BLA-111	Metric Bub to Dom	5	3/8-24 Inv (105B)	M13 x 1.5 Bub (7947)	BR-1447
BLA-112	Metric Bub to Metric Bub	5	M10 x 1.0 Bub (7801)	M12 x 1.0 Bub (7946)	BR-7936

## 1/4" Adapter Brake Lines - 8"

BLA-104	9/16" Dom to 1/4" Dom	5	7/16-24 Inv (105C)	9/16-18 Inv (7958)	BR-7908
BLA-106	5/16" Dom to 1/4" Dom	5	7/16-24 Inv (105C)	1/2-20 Inv (7959)	BR-7829



## 6mm Adapter Brake Lines - 8"

BLA-113	Metric Bub to 6mm	5	M12x1.0 Bub (7961)	M14 x 1.5 Bub (7963)	-
BLA-114	Metric Bub to 6mm	5	M12x1.0 Bub (7961)	M12 x 1.5 Bub (7962)	-

## Fittings Guide For Common Lines & Adapter Lines

Line	Type	Flare	Fitting A	Size	Fitting B	Size
<b>Standard Lines</b>						
3/16"	Domestic	Inv	105B	(3/8-24 Short)	105BL	(3/8-24 Long)
3/16"	British	Bub	7802	(3/8-24)	7802	(3/8-24)
3/16"	European	Bub	7801	(M10 x 1.0)	7801	(M10 x 1.0)
3/16"	Asian	Inv	7800	(M10 x 1.0)	7800	(M10 x 1.0)
1/4"	Domestic	Inv	105C	(7/16-24 Short)	105CL	(7/16-24 Long)
5/16"	Domestic	Inv	105D	(1/2-20)	105D	(1/2-20)
3/8"	Domestic	Inv	105E	(5/8-18)	105E	(5/8-18)
<b>Adapter Lines</b>						
3/16"	Asian to Domestic	Inv/Bub	105B	(3/8-24 Short)	7800	(M10 x 1.0)
3/16"	European to Domestic	Inv/Bub	105B	(3/8-24 Short)	7945	(M11 x 1.5)
3/16"	European to Domestic	Inv/Bub	105B	(3/8-24 Short)	7946	(M12 x 1.5)
3/16"	European to Domestic	Inv/Bub	105B	(3/8-24 Short)	7947	(M13 x 1.5)
3/16"	Dom 1/4" to Dom 3/16"	Inv/Inv	105B	(3/8-24 Short)	7955	(7/16-24)
3/16"	Dom 5/16" to Dom 3/16"	Inv/Inv	105B	(3/8-24 Short)	7956	(1/2-20)
3/16"	European to Domestic	Inv/Bub	105B	(3/8-24 Short)	7801	(M10 x 1.0)
3/16"	Dom 9/16" to Dom 3/16"	Inv/Inv	105B	(3/8-24 Short)	7948	(9/16-18)
1/4"	Dom 9/16" to Dom 1/4"	Inv/Inv	105C	(7/16-24 Short)	7958	(9/16-18)
1/4"	Dom 1/4" to Dom 1/4"	Inv/Inv	105C	(7/16-24 Short)	105C	(7/16-24 Short)
1/4"	Dom 5/16" to Dom 1/4"	Inv/Inv	105C	(7/16-24 Short)	7959	(1/2-20)
<b>Fuel &amp; Transmission Lines</b>						
5/16"	Fuel and Transmission		105D	(1/2-20)	7953	(M14 x 1.5)
3/8"	Fuel and Transmission		105E	(5/8-18)	7954	(M16 x 1.5)

## Unions

Part No.	Tube Size	Thread Size	Flare
 BR-300B	3/16"	3/8"-24	Inverted
 BR-300C	1/4"	7/16"-24	Inverted
 BR-300D	5/16"	1/2"-20	Inverted
 BR-300E	3/8"	5/8"-18	Inverted
 BR-1594	3/16"	3/8"-24 (Brit)	Bubble
 BR-1595A	3/16"	M10x1.0 (Eur)	Bubble
 BR-7934A	3/16"	M10x1.0 (Asian)	Inverted

## Compression Unions



**Not For Use With Braking Systems**

Part No.	Tube Size	Thread Size	Flare
BR-62A	1/8"	N/A	N/A
BR-62B	3/16"	N/A	N/A
BR-62C	1/4"	N/A	N/A
BR-62D	5/16"	N/A	N/A
BR-62E	3/8"	N/A	N/A

## Brake Line Clamps (Stainless Steel)

Part No.	Tube Size	Description
BL-1B	3/16"	Brake Line Clamp 
BL-2B	1/4"	Brake Line Clamp
BL-3B	5/16"	Fuel Line Clamp
BL-4B	3/8"	Fuel Line Clamp

**All Brake Fittings are Sold In Packages of 5**

[www.dynamicautosupplies.com](http://www.dynamicautosupplies.com)

## Bleeder Screws

Part No.	Thread Size	Length
 9400	3/8"-24	1.36
 9401	3/8"-24	1.47
 9402	3/8"-24	1.11
 9403	5/16"-24	1.06
 9404	1/4"-28	.92
 9405	M8x1.25	23.55mm
 9406	M10x1.5	27.5mm
 9407	M10x1.0	27.5mm
 9409	M10x1.0	32.75mm
 9410	M10x1.0	35.0mm
 9411	M7x1.0	32.0mm
 9412	M10x1.0	36.7mm
 9413	M7x1.0	38.55mm
 9415	7/16"-20	1.27
 9421	M10x1.25	33.1mm
 9422	M8x1.25	31.6mm
 9428	M8x1.25	35.5mm
 9430	M8x1.0	26.4mm
 9442	Repair Insert 1/4"-18 NPT	1-1/16
 9443	Repair Insert 7/16"-20 NPT	1-1/16
 9444	Repair Insert 1/8"-27NPT	31/32
 9450	Bleeder Screw Cap	
 9451	Copper Washer I.D. 29/64" x O.D. 11/16"	
 9452	Copper Washer I.D. 1/2" x O.D. 13/16"	
 9453	Copper Washer I.D. 25/64" x O.D. 5/8"	
 9454	Copper Washer I.D. 7/16" x O.D. 13/16"	

**All Bleeder Screws are Sold In Packages of 5**

7.

1-888-571-1141

## Tube Nuts











Part No.	Tube Size	Thread Size	Flare
 BR-105B	3/16"	3/8"-24 Short	Inverted
 BR-105BL	3/16"	3/8"-24 Long	Inverted
 BR-105C	1/4"	7/16"-24 Short	Inverted
 BR-105CL	1/4"	7/16"-24 Long	Inverted
 BR-105D	5/16"	1/2"-20	Inverted
 BR-105E	3/8"	5/8"-18	Inverted
 BR-7800	3/16"	M10x1.0 (Asian)	Inverted
 BR-7801	3/16"	M10x1.0 (Eur)	Bubble
 BR-7802	3/16"	3/8"-24 (Brit)	Bubble
 BR-7943	3/16"	M10x1.0 (Asian)	Inverted
 BR-7945	3/16"	M11x1.5	Bubble
 BR-7947	3/16"	M13x1.5	Bubble

Part No.	Tube Size	Thread Size	Flare
 BR-7947	3/16"	M13x1.5	Bubble
 BR-7948	3/16"	9/16"-18	Inverted
 BR-7950	3/16"	M12x1.0	Bubble
 BR-7951	3/16"	M10x1.0 Long	Inverted
 BR-7952	3/16"	M10x1.0	Bubble
 BR-7955	3/16"	7/16"-24	Inverted
 BR-7956	3/16"	1/2"-20	Inverted
 BR-7957	3/16"	M10x1.0	Bubble
 BR-7958	1/4"	9/16"-18	Inverted
 BR-7959	1/4"	1/2"-20	Inverted
 BR-7961	6mm	M12x1.0	Bubble
 BR-7963	6mm	M14x1.5	Bubble

**All Brake Fittings are Sold In Packages of 5**

## Adapter Fittings

	Part No.	Female Thread	Flare	Male Thread	Flare
	BR-1441	3/8"-24	Inv	3/8"-24	Bub
	BR-1442	3/8"-24	Inv	M10x1.0	Bub
	BR-1443	3/8"-24	Inv	M10x1.0	Inv
	BR-1445	3/8"-24	Inv	M11x1.5	Bub
	BR-1446	3/8"-24	Inv	M12x1.0	Bub
	BR-1447	3/8"-24	Inv	M13x1.5	Bub
	BR-1448	3/8"-24	Inv	M10x1.25	Bub
	BR-7727	1/2"-20	Inv	7/16"-24	Inv
	BR-7818	3/8"-24	Inv	7/16"-24	Inv
	BR-7828	7/16"-24	Inv	3/8"-24	Inv
	BR-7829	7/16"-24	Inv	1/2"-20	Inv

	Part No.	Female Thread	Flare	Male Thread	Flare
	BR-7908	7/16"-24	Inv	9/16"-18	Inv
	BR-7909	3/8"-24	Inv	1/2"-20	Inv
	BR-7910	3/8"-24	Inv	9/16"-20	Inv
	BR-7911	3/8"-24	Inv	9/16"-18	Inv
	BR-7912	9/16"-18	Inv	1/2"-20	Inv
	BR-7913	1/2"-20	Inv	7/16"-24	Inv
	BR-7915	5/8"-18	Inv	1/2"-20	Inv
	BR-7916	1/2"-20	Inv	5/8"-18	Inv
	BR-7935	M10x1.0	Inv	M11x1.5	Bub
	BR-7936	M10x1.0	Inv	M12x1.0	Bub
	BR-7937	M10x1.0	Inv	M13x1.5	Bub

**All Brake Fittings are Sold In Packages of 5**



# Brake Fittings Assortments



Dynamic Brake Fitting Assortments make it easy for any repair shop to keep the most popular fittings on hand and organized. They save time and increase productivity by having the part available when needed.









## No. DY-BLF-1 Brake Line Fittings Assortment

General assortment of tube nuts and unions. Fittings include application for British, European and Asian systems. 14 part numbers and 64 pieces.

<b>BR-105B</b> Tube Nut 3-16 x 3/8-24 Inv  Qty 5	<b>BR-105BL</b> Tube Nut —Long 3-16 x 3/8-24 Inv  Qty 5	<b>BR-105C</b> Tube Nut 1/4 x 7/16-24 Inv  Qty 5	<b>BR-105CL</b> Tube Nut —Long 1/4 x 7/16-24 Inv  Qty 5	<b>BR-105D</b> Tube Nut 5/16 x 1/2-20 Inv  Qty 5	<b>BR-7800</b> Tube Nut (Japanese) M10 x 1.0 Inv  Qty 5
<b>BR-7801</b> Tube Nut (European) 3/16 x M10 x 1.0 Bub  Qty 5	<b>BR-7802</b> Tube Nut (British) 3/16 x 3/8-24 Bub  Qty 5	<b>BR-300B</b> Union 3/16 x 3/8-24 Inv  Qty 5	<b>BR-300C</b> Union 1/4 x 7/16 Inv  Qty 5	<b>BR-300D</b> Union 5/16 x 1/2-20 Inv  Qty 5	<b>BR-1594</b> Union (British) 3/16 x 3/8-24 Bub  Qty 5
<b>BR-1595A</b> Union (European) 3/16 x M10 x 1.0 Bub  Qty 5	<b>BR-7934A</b> Union (Japanese) 3/16 x M10 x 1.0 Inv  Qty 5				

## No. DY-BLF-3 Brake Line Fittings Assortment

General assortment of tube nuts, unions and adapters. 19 part numbers and 95 pieces.





















<b>BR-105B</b> Tube Nut 3/16 x 3/8-24 Inv  Qty 5	<b>BR-105BL</b> Tube Nut —Long 3/16 x 3/8-24 Inv  Qty 5	<b>BR-105C</b> Tube Nut 1/4 x 7/16-24 Inv  Qty 5	<b>BR-105CL</b> Tube Nut —Long 1/4 x 7/16-24 Inv  Qty 5	<b>BR-7800</b> Tube Nut (Japanese) 3/16 x M10 x 1.0 Inv  Qty 5	<b>BR-7801</b> Tube Nut (European) 3/16 x M10 x 1.0 Bub  Qty 5
<b>BR-7802</b> Tube Nut (British) 3/16 x 3/8-24 Bub  Qty 5	<b>BR-300B</b> Union 3/16 x 3/8-24 Inv  Qty 5	<b>BR-300C</b> Union 1/4 x 7/16 Inv  Qty 5	<b>BR-1594</b> Union (British) 3/16 x 3/8-24 Bub  Qty 5	<b>BR-1595A</b> Union (European) 3/16 x M10 x 1.0 Bub  Qty 5	<b>BR-7934A</b> Union (Japanese) 3/16 x M10 x 1.0 Inv  Qty 5
<b>BR-1441</b> Adapter 3/8-24 Inv to 3/8-24 Bub  Qty 5	<b>BR-1442</b> Adapter 3/8-24 Inv to M10x1.0 Bub  Qty 5	<b>BR-7818</b> Adapter 3/8-24 Inv to 7/16-24 Inv  Qty 5	<b>BR-7829</b> Adapter 7/16-24Inv to 1/2-20 Inv  Qty 5	<b>BR-7908</b> Adapter 7/16-24Inv to 9/16-18 Inv  Qty 5	<b>BR-7909</b> Adapter 3/8-24Inv to 1/2-20 Inv  Qty 5
<b>BR-7910</b> Adapter 3/8-24 Inv to 9/16-20 Inv  Qty 5					



# Brake Fittings Assortments

## No. DY-BLF-4 Master Brake Line Fittings Assortment

Master assortment contains 20 different tube nuts and unions to make most domestic and import brake lines. 91 pieces.

<b>BR-105B</b> Tube Nut 3/16 x 3/8-24 Inv  Qty 5	<b>105BL</b> Tube Nut – Long 3/16 3/8-24 Inv  Qty 5	<b>BR-105C</b> Tube Nut 1/4 x 7/16-24 Inv  Qty 5	<b>BR-105CL</b> Tube Nut – Long 1/4 x 7/16-24 Inv  Qty 5	<b>BR-7800</b> Tube Nut (Japanese) 3/16 x M10 x 1.0 Inv  Qty 5	<b>BR-7801</b> Tube Nut (European) 3/16 x M10 x 1.0 Bub  Qty 5
<b>BR-7802</b> Tube Nut (British) 3/16 x 3/8-24 Bub  Qty 2	<b>BR-7945</b> Tube Nut 3/16 x M11 x 1.5 Bub  Qty 4	<b>BR-7946</b> Tube Nut 3/16 x M12 x 1.0 Bub  Qty 4	<b>BR-7947</b> Tube Nut 3/16 x M13 x 1.5 Bub  Qty 4	<b>BR-7948</b> Tube Nut 3/16 x 9/16-18 Inv  Qty 4	<b>BR-7950</b> Tube Nut 1/4 x M12 x 1.0 Bub  Qty 4
<b>BR-7951</b> Tube Nut – Long 3/16 x M10 x 1.0 Inv  Qty 4	<b>BR-7952</b> Tube Nut 3/16 x M10 x 1.0 Bub  Qty 4	<b>BR-7955</b> Tube Nut 3/16 x 7/16-24 Inv  Qty 4	<b>BR-7956</b> Tube Nut 3/16 x 1/2-20 Inv  Qty 4	<b>BR-7961</b> Tube Nut 6mm x M12 x 1.0 Bub  Qty 4	<b>BR-7963</b> Tube Nut 6mm x M14 x 1.5 Bub  Qty 4
<b>BR-1595A</b> Union (European) 3/16 x M10 x 1.0 Bub  Qty 5	<b>BR-7934A</b> Union (Japanese) 3/16 x M10 x 1.0 Inv  Qty 5				

## No. DY-BLU-1 Brake Line Union Assortment

This 14 piece assortment contains the top five brake line unions and both SAE and metric sizes.

BR-300B	BR-300C	BR-1594	BR-1595A	BR-7934A
				
<b>Union</b> 3/16 x 3/8-24 Inv Qty 5	<b>Union</b> 1/4 x 7/16-24 Inv Qty 3	<b>Union</b> (British) 3/16 x 3/8-24 Bub Qty 2	<b>Union</b> (European) 3/16 x M10 x 1.0 Bub Qty 2	<b>Union</b> (Japanese) 3/16 x M10 x 1.0 Inv Qty 2

## No. DY-BA-1 Master Cylinder Adapter Assortment

For converting different sized port openings on master cylinders to standard brake systems. 11 part numbers and 53 pieces.

<b>BR-1441</b> Adapter 3/8-24 (F) Inv to 3/8-24 (M) Bub Qty: 1	<b>BR-7727</b> Adapter 1/2-20 (F) Inv to 7/16-24 (M) Inv Qty: 1	<b>BR-7818</b> Adapter 3/8-24 (F) Inv to 7/16-24 (M) Inv Qty: 3	<b>BR-7828</b> Adapter 7/16-24 (F) Inv to 3/8-24 (M) Inv Qty: 2	<b>BR-7829</b> Adapter 7/16-24 (F) Inv to 1/2-20 (M) Inv Qty: 3	<b>BR-7908</b> Adapter 7/16-24 (F) Inv to 9/16-18 (M) Inv Qty: 2
<b>BR-7909</b> Adapter 3/8-24 (F) Inv to 1/2-20 (M) Inv Qty: 2	<b>BR-7910</b> Adapter 3/8-24 (F) Inv to 9/16-20 (M) Inv Qty: 1	<b>BR-7911</b> Adapter 3/8-24 (F) Inv to 9/16-18 (M) Inv Qty: 2	<b>BR-7912</b> Adapter 9/16-18 (F) Inv to 3/8-24 (M) Inv Qty: 1	<b>BR-7913</b> Adapter 1/2-20 (F) Inv to 7/16-24 (M) Inv Qty: 1	

## No. DY-BA-2 Metric Adapter Assortment

For converting different port openings on master cylinders to standard brake systems. All metric sizes. Nine part numbers 27 pieces.

<b>BR-1442</b> Adapter 3/8-24 Inv to M10x1.0 Bub Qty: 3	<b>BR-1443</b> Adapter 3/8-24 Inv to M10x1.0 Inv Qty: 3	<b>BR-7937</b> Adapter M10 x 1.0 Inv to M13 x 1.5 Bub Qty: 3	<b>BR-1445</b> Adapter 3/8-24 Inv to M11 x 1.5 Bub Qty: 3	<b>BR-1446</b> Adapter 3/8-24 Inv to M12x1.0 Bub Qty: 3
<b>BR-1447</b> Adapter 3/8-24 Inv to M13x1.5 Bub Qty: 3	<b>BR-1448</b> Adapter 3/8-24 Inv to M10 x 1.25 Bub Qty: 3	<b>BR-7935</b> Adapter M10 x 1.0 Inv to M11 x 1.5 Bub Qty: 3	<b>BR-7936</b> Adapter M10 x 1.0 Inv to M12 x 1.0 Bub Qty: 3	

## No. DY-BLF-44 Master Brake Line Fittings Center

The Dynamic BLF-34 Brake Fittings Center contains all of the popular fittings used for brake line repair and replacement. This assortment includes tube nuts for 3/16" and 1/4" brake line - SAE and Metric sizes, unions and master cylinder adapters.

- Essential for shops doing extensive brake line repair.
- Saves time - increases productivity and profitability.
- 232 pieces and 30 different part numbers.

- Packed in color-coded boxes for easy identification.
- Easy to reorder.
- Easy to keep organized.
- Includes a sturdy steel wall rack - measures 24"H x 13"W

Assortment includes the following:

Part No.	Qty	Part No.	Qty	Part No.	Qty	Part No.	Qty
<b>Tube Nuts</b>		<b>Tube Nuts</b>		<b>Unions</b>		<b>Adapters</b>	
BC-105B	20	BC-7947	8	BC-1594	4	BC-1441	5
BC-105BL	10	BC-7948	8	BC-1595A	8	BC-1442	5
BC-105C	10	BC-7950	8	BC-300B	10	BC-7818	5
BC-105CL	10	BC-7951	8	BC-300C	8	BC-7829	5
BC-7800	8	BC-7952	8	BC-7934A	5	BC-7908	5
BC-7801	8	BC-7955	8			BC-7909	5
BC-7802	8	BC-7956	8			BC-7910	5
BC-7945	8	BC-7961	8				
BC-7946	8	BC-7963	8				

## No. DY-BSA-1 Bleeder Screw Assortment

Most popular bleeder screws, repair inserts, copper washers and bleeder screw caps. 19 part numbers and 105 pieces.

<b>9400</b> Length—1.36 Thread—3/8"×24 Qty: 5	<b>9401</b> Length—1.47 Thread—3/8"×24 Qty: 5	<b>9402</b> Length—1.11 Thread—3/8"×24 Qty: 10	<b>9403</b> Length—1.06 Thread—5/16"×24 Qty: 5	<b>9404</b> Length—.92 Thread—1/4"×28 Qty: 5	<b>9405</b> Length—23.5mm Thread—M8 x 1.5 Qty: 5
<b>9406</b> Length—27.5 Thread—M10 x 1.5 Qty: 10	<b>9410</b> Length—35.0 Thread—M10 x 1.0 Qty: 5	<b>9411</b> Length—32.0 Thread—M7 x 1.0 Qty: 5	<b>9413</b> Length—38.55 Thread—M7 x 1.0 Qty: 5	<b>9415</b> Length—1.27 Thread—7/16"×20 Qty: 5	<b>9442</b> Length—1.18" Thread—1/4"×18 NPT (REPAIR INSERT) Qty: 5
<b>9443</b> Length—1.16" Thread—7/16"×20 NPT (REPAIR INSERT) Qty: 5	<b>9444</b> Length—3132" Thread—18"×27 NPT (REPAIR INSERT) Qty: 5	<b>9451</b> I.D.—29/64" O.D.—11/16" Copper Washer Qty: 5	<b>9452</b> I.D.—1/2" O.D.—13/16" Copper Washer Qty: 5	<b>9453</b> I.D.—25/64" O.D.—5/8" Copper Washer Qty: 5	<b>9454</b> I.D.—7/16" O.D.—13/16" Bleeder Screw Cap Qty: 5

## No. DY-BSA-2 Bleeder Screw Assortment

Most popular bleeder screws and washers. Ten part numbers and 30 pieces.

<b>9401</b> Length—1.47 Thread—3/8"×24 Qty: 5	<b>9402</b> Length—1.11 Thread—3/8"×24 Qty: 10	<b>9403</b> Length—1.06 Thread—5/16"×24 Qty: 5	<b>9406</b> Length—27.5 Thread—M10 x 1.5 Qty: 10	<b>9410</b> Length—35.0 Thread—M10 x 1.0 Qty: 5
<b>9415</b> Length—1.27 Thread—7/16"×20 Qty: 5	<b>9442</b> Length—1.16" Thread—1/4"×18 NPT (REPAIR INSERT) Qty: 5	<b>9451</b> I.D.—29/64" O.D.—11/16" Copper Washer Qty: 5	<b>9453</b> I.D.—25/64" O.D.—5/8" Copper Washer Qty: 5	<b>9454</b> I.D.—7/16" O.D.—13/16" Copper Washer Qty: 5



## Connectors – Straight

### Quick Disconnect – (O.E. Style)



Part No.	Female Connection	Male Connect To Fuel Line	Pkg. Qty.	Retainer
FCS-48	1/4"	5/16"	2	N/A

### Quick Disconnect – (Push Button)



TCS-58	5/16"	5/16"	2	CL-103B
TCS-68	3/8"	5/16"	2	CL-102B
TCS-510	5/16"	3/8"	2	CL-103B
TCS-610	3/8"	3/8"	2	CL-102B
PCS-610	3/8"	3/8"	2	CL-102B

## O.E.M. Fuel Line

### Nylon Fuel Line Tubing

Part No.	Tube Size	Pkg. Qty.
FL-14	1/4"	25'
FL-56	5/16"	25'
FL-38	3/8"	25'



## GM Fuel Sender Adapters

### To Rubber Fuel Line

Part No.	Female	Male	Pkg. Qty.
FH-14	14mm	5/16"	5
FH-16	16mm	3/8"	5



### To Nylon Fuel Line

FS-14	14mm	5/16"	5
FS-16	16mm	3/8"	5



## Clamps

### 360 For Nylon & Rubber Hose

Part No.	Tube Size	Pkg. Qty.
CSO-14	1/4"	10
CSO-56	5/16" (8mm)	10
CSO-38	3/8" (10mm)	10



### Fuel Injection Clamps

HCM-4F	1/4"	10
HCM-6F	5/16"	10
HCM-8F	3/8"	10



## Connectors – 90° Bend

### Quick Disconnect – (Push Button)



Part No.	Female Connection	Male Connect To Fuel Line	Pkg. Qty.	Retainer
TCB-58	5/16"	5/16"	2	CL-130B
TCB-68	3/8"	5/16"	2	CL-102B
TCB-510	5/16"	3/8"	2	CL-103B
TCB-610	3/8"	3/8"	2	CL-102B

## Fittings

### Compression Union - Nylon to Nylon

Part No.	Thread Size	Pkg. Qty.
BR-62CNN	1/4"	2
BR-62DNN	5/16"	2
BR-62ENN	3/8"	2



### Compression Union - Nylon to Steel

BR-62CNS	1/4"	2
BR-62DNS	5/16"	2
BR-62ENS	3/8"	2



### Brass Splice Joiners For Nylon Fuel Line

BB-14	1/4"	5
BB-516	5/16"	5
BB-38	3/8"	5
BB-45	1/4"-5/16"	5
BB-53	5/16"-3/8"	5



### Brass Splice Joiners For Nylon Rubber Line

BFC-3	3/16"	5
BFC-4	1/4"	5
BFC-5	5/16"	5
BFC-6	3/8"	5



## O-Rings

### Viton O-Rings For Steel Fuel Repair Lines



Part No.	Size Line	Pkg. Qty.
OR-38	3/8"	10
OR-516	5/16"	10

## Fuel Line Adapters

### Steel To Nylon or Rubber Line



Part No.	Female	Male	Pkg. Qty.
AL-101B	1/4"	1/4"	2
AL-102B	5/16"	5/16"	2
AL-103B	3/8"	3/8"	2

### Connects GM To Nylon Or Rubber



AL-104B	14mm	5/16"	2
AL-105B	16mm	3/8"	2

### Connects Nylon To Rubber Hose



AL-106B	5/16"	5/16"	2
AL-107B	3/8"	3/8"	2

## Steel Line Repair Lines

### 14mm With Fitting And O-Ring



Part No.	Size Line	Length	Pkg. Qty.
FL-510B	5/16"	9"	2
FL-518B	5/16"	18"	2
FL-530B	5/16"	30"	2

### 16mm With Fitting And O-Ring



FL-610B	3/8"	9"	2
FL-618B	3/8"	18"	2
FL-630B	3/8"	30"	2

## Fuel Sending Unit Repair Lines

### 180° Fuel Filter Repair Line w/16mm GM Fitting



FL-6188B	3/8"	6-1/2"	2
----------	------	--------	---

## No. DY-FLA-2 Fuel Line Connector Assortment

 Size F-1/4 M-5/16 Fuel Line Quick Connector-Straight Ford Products <b>FCS-48</b> Qty 2	 Size F-5/16 M-5/16 Fuel Line Quick Connector-Straight GM, Ford, Chrysler Prod. <b>TCS-58</b> Qty 2	 Size F-3/8 M-3/8 Fuel Line Quick Connector-Straight GM, Ford, Chrysler Prod. <b>TCS-610</b> Qty 2	 Size F-5/16 M-3/8 Fuel Line Quick Connector-Straight GM, Ford, Chrysler Prod. <b>TCS-510</b> Qty 2	 Size F-3/8 M-5/16 Fuel Line Quick Connector-Straight GM, Ford, Chrysler Prod. <b>TCS-68</b> Qty 2	 Size F-5/16 M-5/16 Fuel Line Quick Connector-90 degree GM, Ford, Chrysler Prod. <b>TCS-58</b> Qty 2
 Size F-3/8 M-3/8 Fuel Line Quick Connector-90 degree GM, Ford, Chrysler Prod. <b>TCB-610</b> Qty 2	 Size F-3/8 M-5/16 Fuel Line Quick Connector-90 degree GM, Ford, Chrysler Prod. <b>TCB-68</b> Qty 2	 Size F-5/16 M-3/8 Fuel Line Quick Connector-90 degree GM, Ford, Chrysler Prod. <b>TCB-510</b> Qty 2	 Size 1/4" Fuel Line Connector Brass All Vehicles <b>BB-14</b> Qty 2	 Size 5/16" Fuel Line Connector Brass All Vehicles <b>BB-516</b> Qty 5	 Size 3/8" Fuel Line Connector Brass All Vehicles <b>BB-38</b> Qty 5
 Size 1/4" Brass Compression Union Nylon to Nylon All Vehicles <b>BR-62CNN</b> Qty 2	 Size 5/16" Brass Compression Union Nylon to Nylon All Vehicles <b>BR-62DNN</b> Qty 2	 Size 3/8" Brass Compression Union Nylon to Nylon All Vehicles <b>BR-62ENN</b> Qty 2	 Size 1/4" Brass Compression Union Nylon to Steel All Vehicles <b>BR-62CNS</b> Qty 2	 Size 5/16" Brass Compression Union Nylon to Steel All Vehicles <b>BR-62DNS</b> Qty 2	 Size 3/8" Brass Compression Union Nylon to Steel All Vehicles <b>BR-62ENS</b> Qty 2
 Size 1/4" Fuel Line Clamp 360 degree All Vehicles <b>CSO-14</b> Qty 5	 Size 5/16" Fuel Line Clamp 360 degree All Vehicles <b>CSO-56</b> Qty 10	 Size 3/8" Fuel Line Clamp 360 degree All Vehicles <b>CSO-38</b> Qty 10	 Size 5/16" Fuel Line Viton O-Rings GM Products <b>OR-516</b> Qty 10	 Size 3/8" Fuel Line Viton O-Rings GM Products <b>OR-38</b> Qty 10	 Size 5/16" & 3/8" Connector Removal Tool All Vehicles <b>DT-1</b> Qty 1



## Fuel Line Quick Assembly Tool

Makes nylon fuel line repair fast and easy.

- Installs straight or 90° connectors and barbed fittings.
- Saves time and money.
- Create custom size lines - any length
- 11-piece tool comes in durable plastic case.

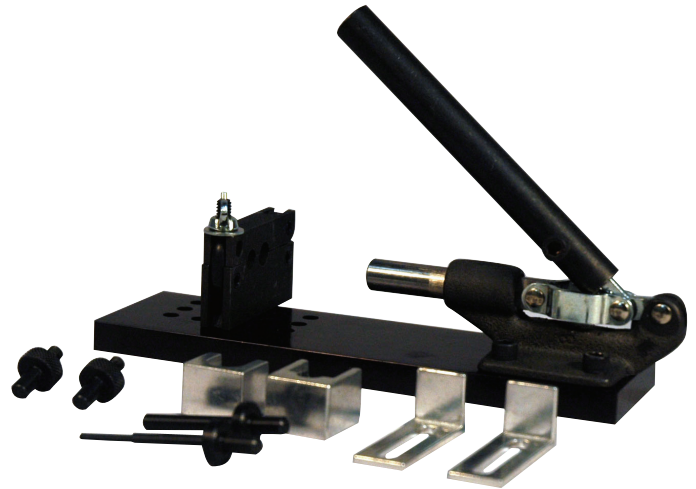

**No. AFP-1000**

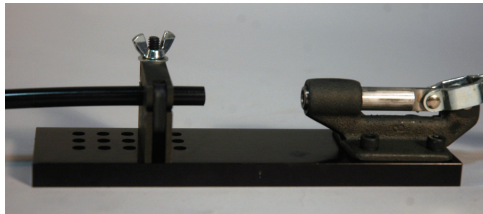

**Step One:**  
Secure fuel line (5/16" or 3/8" into fuel line holder.)

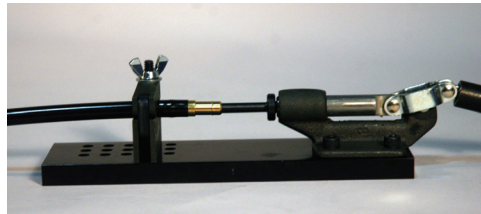

**Step Two:**  
Position fitting or connector to be installed in the end of the hose and move the handle forward pushing the fitting into the hose.

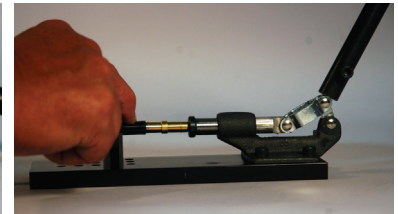

**Step Three:**  
Remove the hose and turn it around and repeat Step Two with another fitting or connector.

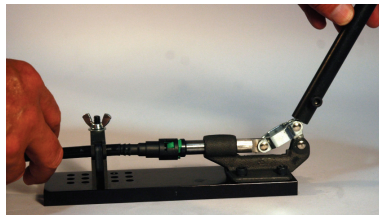

For 90° connectors use the special fitting bracket.

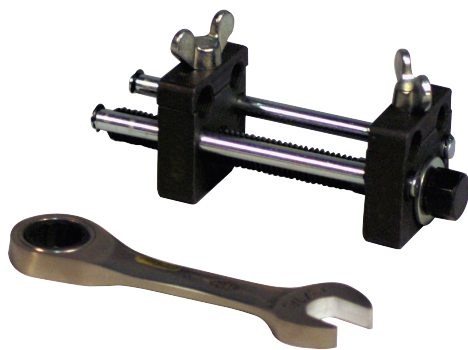
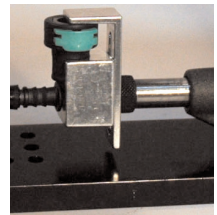

**No. AFP-2000 Fuel Line Assembly Tool**

Attaches fuel line repair assemblies to nylon fuel line on the vehicle.

- Repairs splits in nylon fuel lines.
- Works with 5/16" and 3/8" nylon fuel line.
- Can be used on or off the car.
- Light and portable.
- Works great in tight spaces.
- Includes 9/16" ratcheting wrench.
- Includes durable blow-molded case.

**No. DT-1 Quick Disconnect Retainer Removal Tool**

For 5/16" & 3/8"

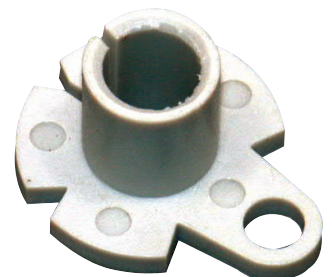



**A Division of  
JohnDow Industries, Inc.**

151 Snyder Avenue • Barberton, OH 44203

Toll-Free Phone: 888.571.1141

Fax: 330.753.6419

Web: [www.dynamicautosupplies.com](http://www.dynamicautosupplies.com)

Email: [customerservice@johndow.com](mailto:customerservice@johndow.com)